

Digital Predistortion and Measurement Method

XING Rongxin^{1,2}, WANG Han^{1,2}, HU Yurong², WEI Liang²,
CHEN Xiaosong², WU Yongming²

(1. *China Electronics Standardization Institute, Beijing 100176;*

2. *Shenzhen CESI Information Technology Co., Ltd, Shenzhen 518052*)

Abstract: Digital PreDistortion (DPD) is a very useful method to improve the linearity of Power Amplifiers (PAs) for LTE and upcoming 5G networks. As the spectrum resources are becoming more and more crowded, and the communications bandwidth are broader, the ACPR (Adjacent Channel Leakage Ratio) is very important to communication systems. DPD is one of the useful means for PA to reduce ACPR. This article demonstrates what DPD is and how DPD is achieved, the measurement of the Digital Distortion of a PA using a vector generator and vector analyzer, and the measurement results has been discussed.

Key words: Digital PreDistortion; DPD; 5G; Vector Signal Generator; Vector Signal Analyzer

1 Introduction

Power amplifier is widely used in wireless communication systems, such as 5G and LTE. Fig.1 shows where the Power Amplifiers (PAs) located in a communication system. The function of PAs is to amplify the modulated band signal to the required power level. There may be several PAs in one communication system due to the multi-stage amplifying and multi-frequency. In practical application, in order to improve the efficiency of power amplifier, the power amplifier needs to work near the saturation area. However, working at saturation area, may cause the power amplifier's non-linearity. The non-linearity inducing the in-band distortion and out-of-band distortion of the signal. In-band distortion is mainly manifested in AM/AM and AM/PM modulation effects, which leads to signal amplitude and phase distortion. These undesired modulations can deflect the constellation, induce the deterioration of bit error rate, etc. Out-of-band distortion can cause interfere to the adjacent channels.

There are three means that can be done to improve the linearity of PA which working near the saturation area. The first one is to reduce the output power of PA to 1dB below saturation power, which is the simplest linearization method. It can improve the linearity of the system without adding other components in the system. However, its disadvantage is also very obvious: because the PA works in the linear region, the efficiency of the system will be greatly reduced.

The second one is called negative feedback technology, which has been widely used in all kinds of PAs. In the RF circuit, the basic function of feedback is that a part of the output power from PA is fed back to the input through the coupling network. After the input signal passes through the feedback network, it will generate a distortion signal with the same amplitude and opposite phase as to the nonlinear distortion signal generated by the PA. The input and the feedback signal sent to the PA together as the corrected input to the PA. By this means to achieve the purpose of linearization. The shortcoming of this measure is that more components have to be added, and it is not suitable for broadband PAs.

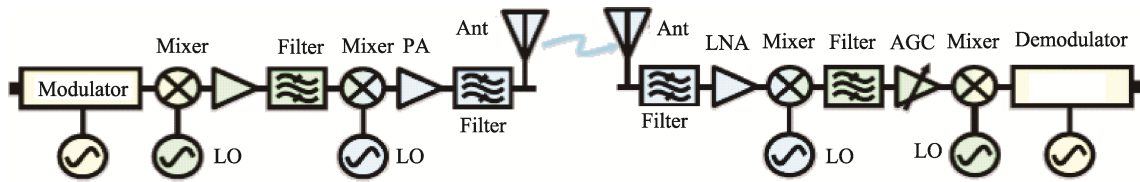

Fig.1 PAs in Wireless Communication System

The third one is called PreDistortion (PD). Pre-distortion technology is a common linearization technology of PA, which is widely used in microwave and satellite communication, 5G, etc. Predistortion technology is an open-loop technology. Its compensation effect is not as well as that of closed-loop, but it has the advantages of high stability, wide bandwidth and low cost compared with other linearization technology. According to the position of digital predistorter, it can be divided into three types: RF predistortion, IF predistortion and Base-band predistortion. Digital Pre-Distortion (DPD) is one of the predistortion methods, which is suitable for PA of digital modulation system. In DPD, the I signal and the Q signal can be predistorted separately.

2 DPD

PA inevitably produces amplitude and linear distortion, especially for those working at the compression point. DPD can correct the AM/AM and the AM/PM effects of PA, so that improve the linearity of the PA. DPD can also increase the compression point of output power to a higher level, thereby increase the efficiency. The Characteristic curve of DPD is shown in Fig.2.

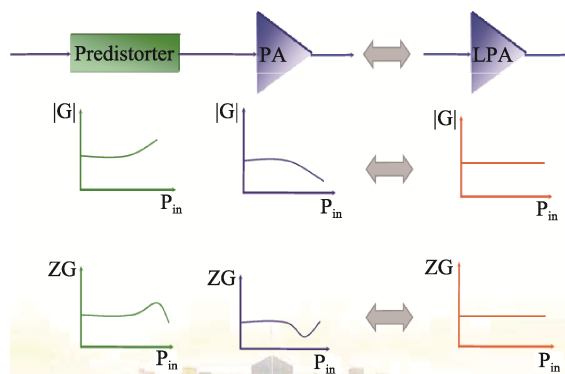

Fig.2 Characteristic Curve of DPD

DPD is to impose distortion to the input of a PA, by inserting a predistorter. The characteristics of predistorter are to distort the input signal as to correct the distortion of the power amplifier. After cascading, the PA becomes a linear system, and the relationship between signal input and output is linear. However, DPD cannot correct signals which the peaks extend a lot to surpass the saturation point due to the high clipping of signal.

The implementation of DPD is to sample the input signal and the output signal of PA, and calculate the error and the compensation. The compensation added to the input of PA, to correct the distortion of PA. The compensation contains correction values for amplitude and phase. The procedure of measuring compensation may be iterated many times, till the expected linearity achieved.

The principle of DPD is illustrated in Fig.3. The measurement of the distortion and the calculation of the compensation are the key points of DPD. In Fig.3, that means to measure the transfer function of predistorter $[h(p, f), p$ stands for power, f stands for frequency]. $h(p, f)$ can be a chart or a polynomial.

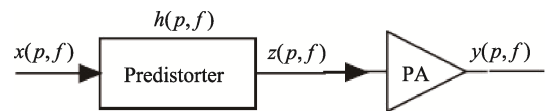

Fig.3 Principle of DPD

3 Measurement of the DPD Performance of PAs

DPD performance measurement of PA is illustrated in Fig.4. The measurement system consists a vector signal generator (VSG) and a vector signal analyzer (VSA).

To perform DPD measurement, the following steps need to be followed. First step, connect the 10MHz reference of VSG with that 10MHz reference of VSA. The base-band IQ signal of IQ generator is input to the VSG. And the IQ of output signal is measured after the base-band signal passes through VSG and VSA. Second step, put a PA as DUT and an attenuator between the VSG and VSA. The purpose of adding the attenuator is to prevent the VSA from damage by the output signal of PA. By measuring the IQ of output signal after the base-band signal passes through VSG, PA, attenuator and VSA, the transfer function of predistorter $h(p, f)$ can be achieved.

4 Measurement Results

A measurement of DPD has been performed using

the R&S SMW 200A vector signal generator with option k-541 and FSW vector signal analyzer with option k-18. The test setup is shown in Fig.5.

The measurement process is controlled by FSW-K18 software, which can measure the AM/AM and/or the AM/PM predistortion in real time and EVM. DPD feature depends on the type of modulation type. The predistortion feature works with any base-band signal. Fig.6 shows the signal flow for DPD. FSW that obtains the distortion model of the PA by calculating the measurement signal and the reference signal, then accomplish the predistortion measurement using FSW-k18 under different powers and frequencies. By using this procedure, the nonlinear model is got for DPD. The model or chart can be an input for predistorter to improve the linearity of PA.

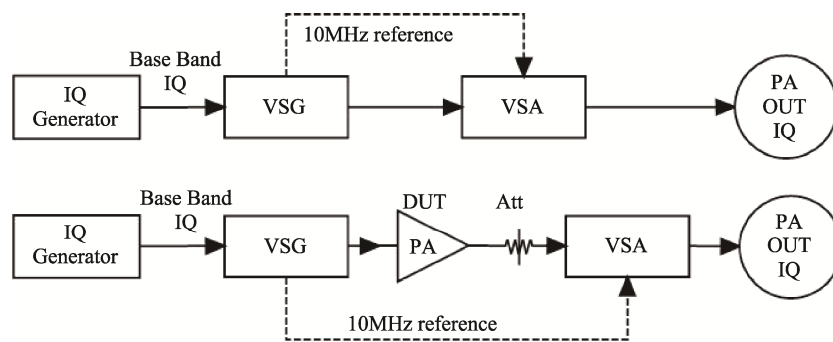

Fig.4 DPD Test Setup

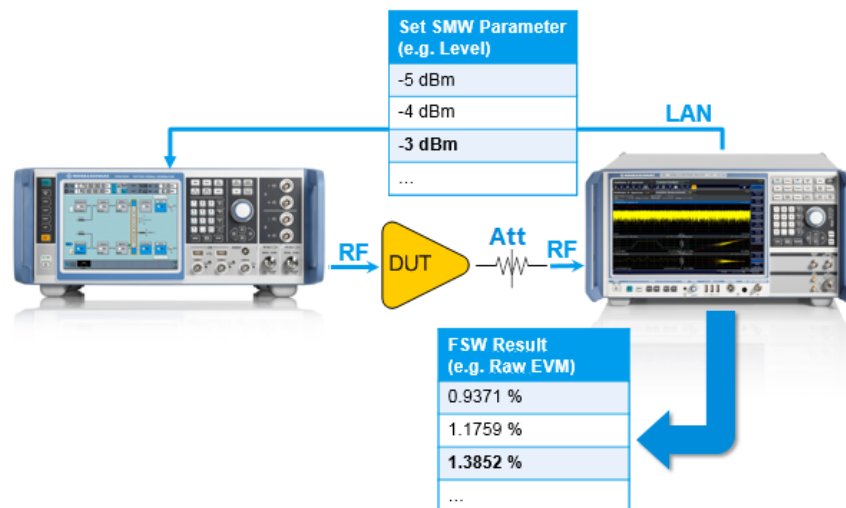

Fig.5 DPD Measurement with SMW200A and FSW

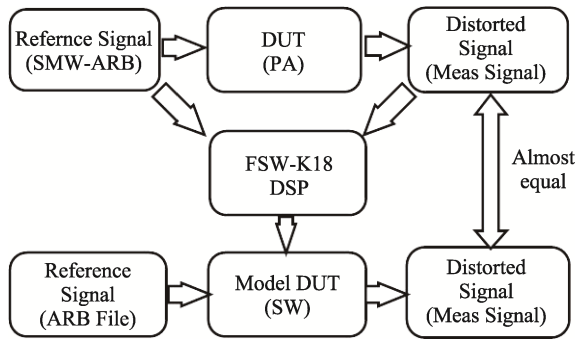

Fig.6 Signal Flow for DPD

Many factors can cause distortion to PA. Among these factors, both nonlinear region and modulation bandwidth are the most common factors. In order to verify the influence of output power and the modulation bandwidth on DPD, this paper carries out the comparative measurements under two conditions. First One is to test the DPD under different levels of output power with fixed modulation bandwidth. The other one is to measure the DPD of device under different modulation bandwidths with fixed output power. The DUT is a PA with the nominal P1dB output power of 25dBm.

4.1 DPD at Different Levels of Output Power

As for the effect of power level, one is in the linear working area, the other one is in the state of P1dB

point. The modulation bandwidth is fixed to 20MHz in all measurements of section 4.1. Under two levels of output power, EVM and ACLR of PA output are measured with and without DPD. In the meantime, curves of phase deviation and AM/AM are compared. So as to evaluate the actual effect of DPD. Table 1 shows EVM and ACLR under different power with/without DPD.

It can be seen from Table 1, EVM parameter after DPD are optimized under different output power. For ACLR parameters, the DPD optimization is more effective under P1dB point.

Table 1 EVM and ACLR under Different Power

Power Level	Parameter	Without DPD	With DPD
20dBm	EVM	1.863%	0.491%
	ACLR	-43.99dBc	-40.61dBc
25dBm	EVM	6.361%	1.275%
	ACLR	-24.75dBc	-27.79dBc

Fig.7 shows the Phase Deviation without/without DPD under 20dBm. Fig.8 shows the Phase Deviation without and without DPD under 25dBm.

Through the comparison between Fig.7 and Fig.8, it is not difficult to find that with the increase of output

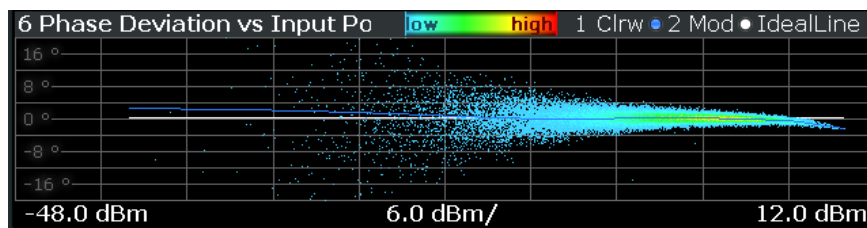

(a) Without DPD

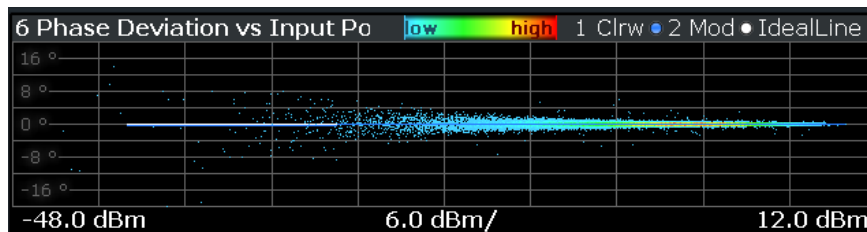

(b) With DPD

Fig.7 Phase Deviation under 20dBm

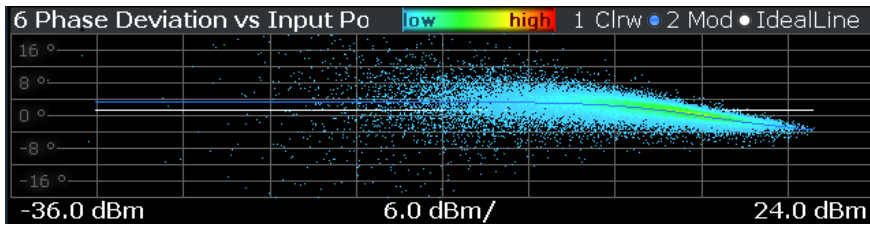

(a) Without DPD

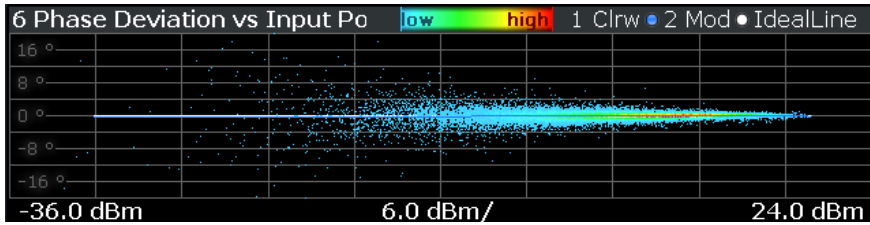

(b) With DPD

Fig.8 Phase Deviation under 25dBm

power from the linear area to P1dB, the deterioration of the phase deviation of the PA is aggravated. However, after DPD optimization, the same phase deviation results are obtained. It shows that DPD is very effective in optimizing phase deviation for PA working in P1dB.

In the same way, Fig.9 and Fig.10 show the AM/AM curve without/with DPD under 20dBm and 25dBm respectively.

Through Fig.9 and Fig.10, the effect of DPD on

AM/AM is not obvious no matter if the PA is working in linear or nonlinear area.

4.2 DPD at Different Modulation Bandwidths

Use the same method, the article performed a comparison measurement to evaluate the DPD performance at the modulation bandwidth of 20MHz and 100MHz. The output power is fixed to 25dBm in all measurements of section 4.2.

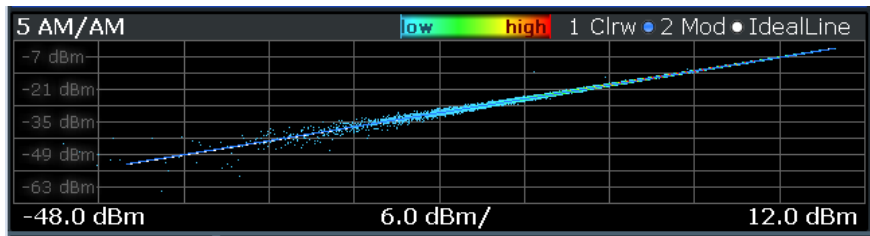

(a) Without DPD

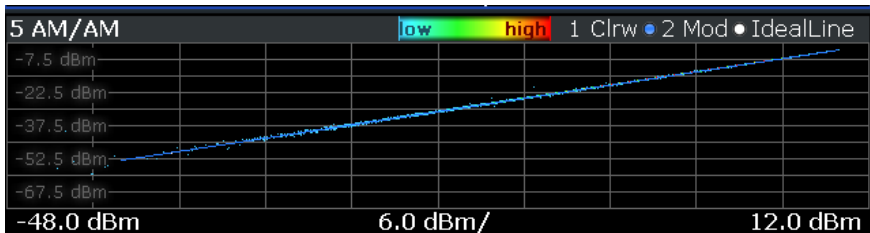

(b) With DPD

Fig.9 AM/AM under 20dBm

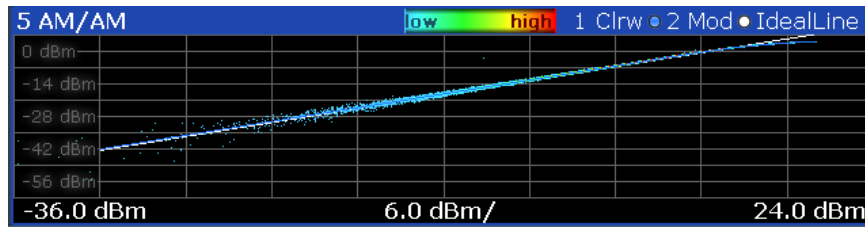

(a) Without DPD

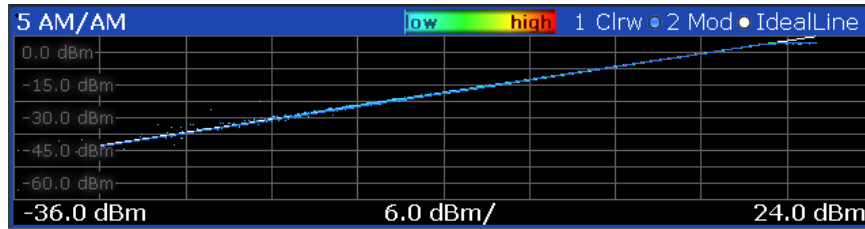

(b) With DPD

Fig.10 AM/AM under 25dBm

Table 2 shows EVM and ACLR under different modulation bandwidths with/without DPD. Through Table 2, the larger of modulation bandwidth, the worse deterioration of EVM and ACLR performance. In different modulation bandwidths, EVM and ACLR are optimized by DPD. The degree of optimization is almost the same.

Table 2 EVM and ACLR under Different Modulation Bandwidths

Modulation Bandwidth	Parameter	Without DPD	With DPD
20MHz	EVM	6.361%	1.275%
	ACLR	-24.75dBc	-27.79dBc
100MHz	EVM	7.388%	1.401%
	ACLR	-25.20dBc	-28.13dBc

5 Conclusion

With the increasing shortage of wireless communication spectrum resources, the protection band between channels is becoming smaller and smaller. At the same time, with the application of 256QAM, OFDM and other complex modulation methods in 5G communication. The requirement of communication system for signal distortion is higher and higher, which

requires higher output linearity of PAs. Hence, the DPD technology effectively improves the linear range and linearity of PA, which is significant for 5G communication system. This article gives a method to measure the DPD performance of PAs. In summary, DPD is very effective for the PA working in the non-linear area no matter what the modulation depth is.

Acknowledgement

The paper is supported by Shenzhen Strategic Emerging Industry Development Fund Project—Public service platform for 5G key components testing (20170921165224440).

References

- [1] Xie Maolin, Yu Tianxiang. (2013). Design of a new pre-distortion linearizer. *Science Technology and Engineering*. 13 (14), pp. 3873-3878.
- [2] Gu Linhai, Ge Lijia. (2015) Current situation and future development of digital predistortion technology of power amplifier. *Communication technology*. 48 (11), pp. 1207-1212.
- [3] Wang Lichun. (2018). Digital predistortion test scheme of broadband power amplifier. *Telecommunication network technology*. (2), pp. 87-90.
- [4] HOLZER, Yuan Wen, WALLING. (2018) Wideband techniques for outphasing power amplifiers. *IEEE*

Transactions on Circuits and Systems I: Regular Papers. 65(9), pp. 2715-2725.

- [5] Deng Hailin, Zhang Dewei, Zhou Dongfang. (2016). Nonlinear characteristic analysis of microwave power amplifier. *Telecommunication technology*. 56(12), pp. 1393-1399.
- [6] Pablo Pascual Campo. (2019). Digital Predistortion for 5G Small Cell: GPU Implementation and RF Measurements. *Journal of Signal Processing Systems*. (12), pp. 76-78.
- [7] Kong Liang, He Yu. (2019). Research on digital predistortion model extraction based on systemvue. *Electronics Quality*. (12), pp. 18-21, 26.
- [8] Ma Jingyan, etc. (2020). Research on Radio Frequency Algorithms of 5G Millimeter-wave. *Designing Techniques of Posts and Telecommunications*. (3), pp. 10-14.
- [9] Tan Dalun, Zhang Hai. (2019). Application of Digital Pre-distortion OP6180 in Macro Basestation. *Communications Technology*. 52(6), pp.1534-1540.
- [10] MIAO Xiang, WAN Fayu. (2019). Digital Predistortion Based on Parameter Selection. *Telecommunication Engineering*. (12), pp. 1464-1468.
- [11] Zhu Jiangmiao, Qiao Mengyuan. (2020). Research on calibration of arbitrary waveform generator based on predistortion algorithm. *Journal of Electronic Measurement and Instrumentation*. (5), pp. 122-126.
- [12] Xiao Research on Digital Predistortion Technology in 5G Wireless Communication. *China Computer & Communication*. (15), pp. 190-191, 194.
- [13] Xu Jianzhong. (2018). Application of DPD in the Wireless Chip and Analysis of Its Performance Affected Factors. *Applications of IC*. (8), pp. 13-16.
- [14] Qu Yun, Nan Jingchang. Study on New Digital Pre-Distortion Method for RF Power Amplifier. *Microelectronics*. (3), pp. 440-444.
- [15] Pang Zihong. Nonlinear Distortion Optimization of RF Power Amplifier for Wireless Communication. *INFORMATION & COMMUNICATIONS*. (6), pp.

Author Biographies



XING Rongxin, received master degree from Beihang University in 2004. Now he works for China Electronics Standardization Institute and Shenzhen CESI Information Technology Co. His main research interest is microwave components measurement and calibration.

Email: 15901519692@139.cm



WANG Han, received master degree from Beijing University in 2020. Now she works for China Electronics Standardization Institute and Shenzhen CESI Information Technology Co. Her main research interest is integrated circuit testing and measurement of conductor instruments and equipment.

Email: wanghan@cesi.cn



Copyright: © 2020 by the authors. This article is licensed under a Creative Commons Attribution 4.0 International License (CC BY) license (<https://creativecommons.org/licenses/by/4.0/>).